

⑤ **BOTTOM VIEW**

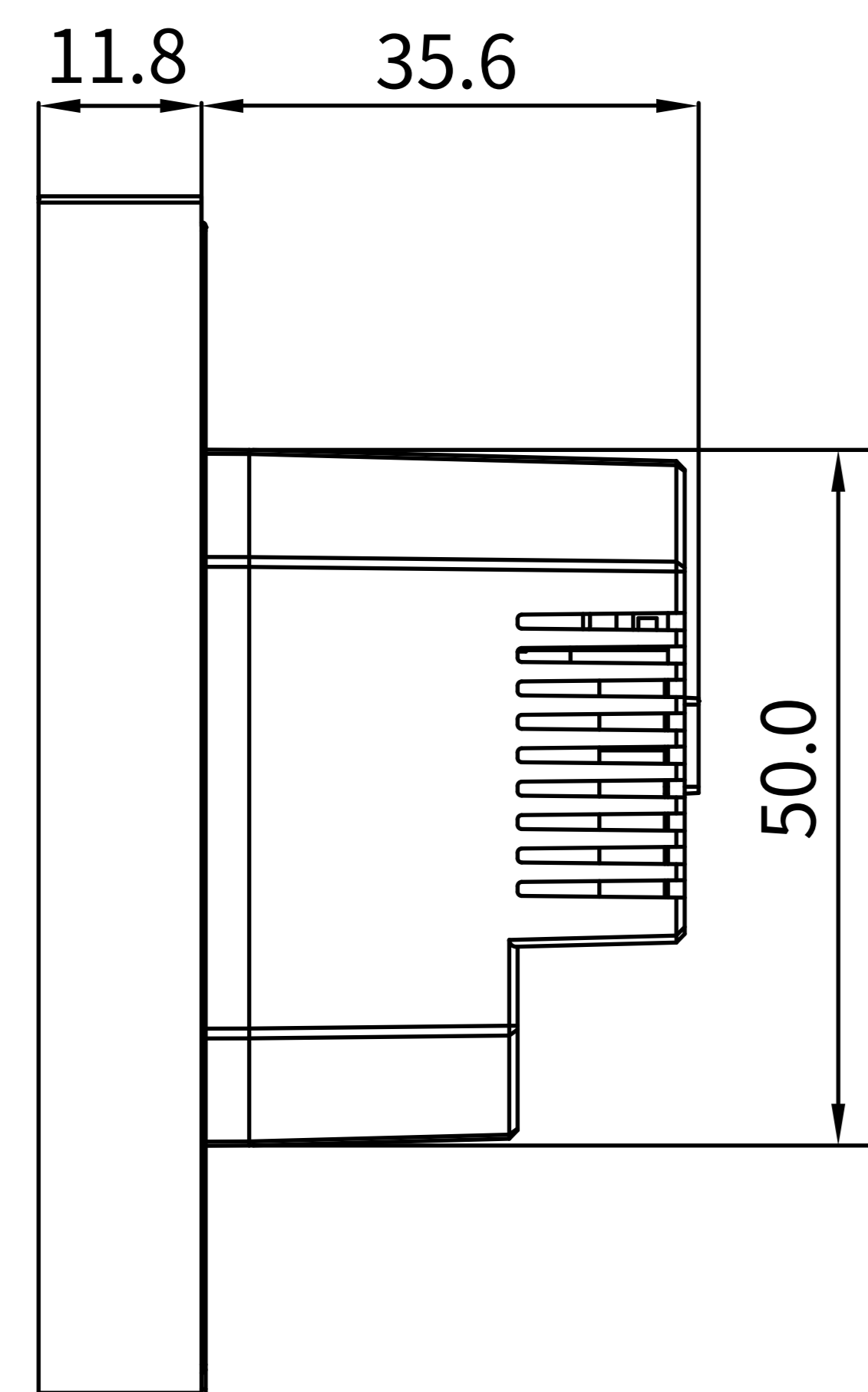

② **RIGHT VIEW**

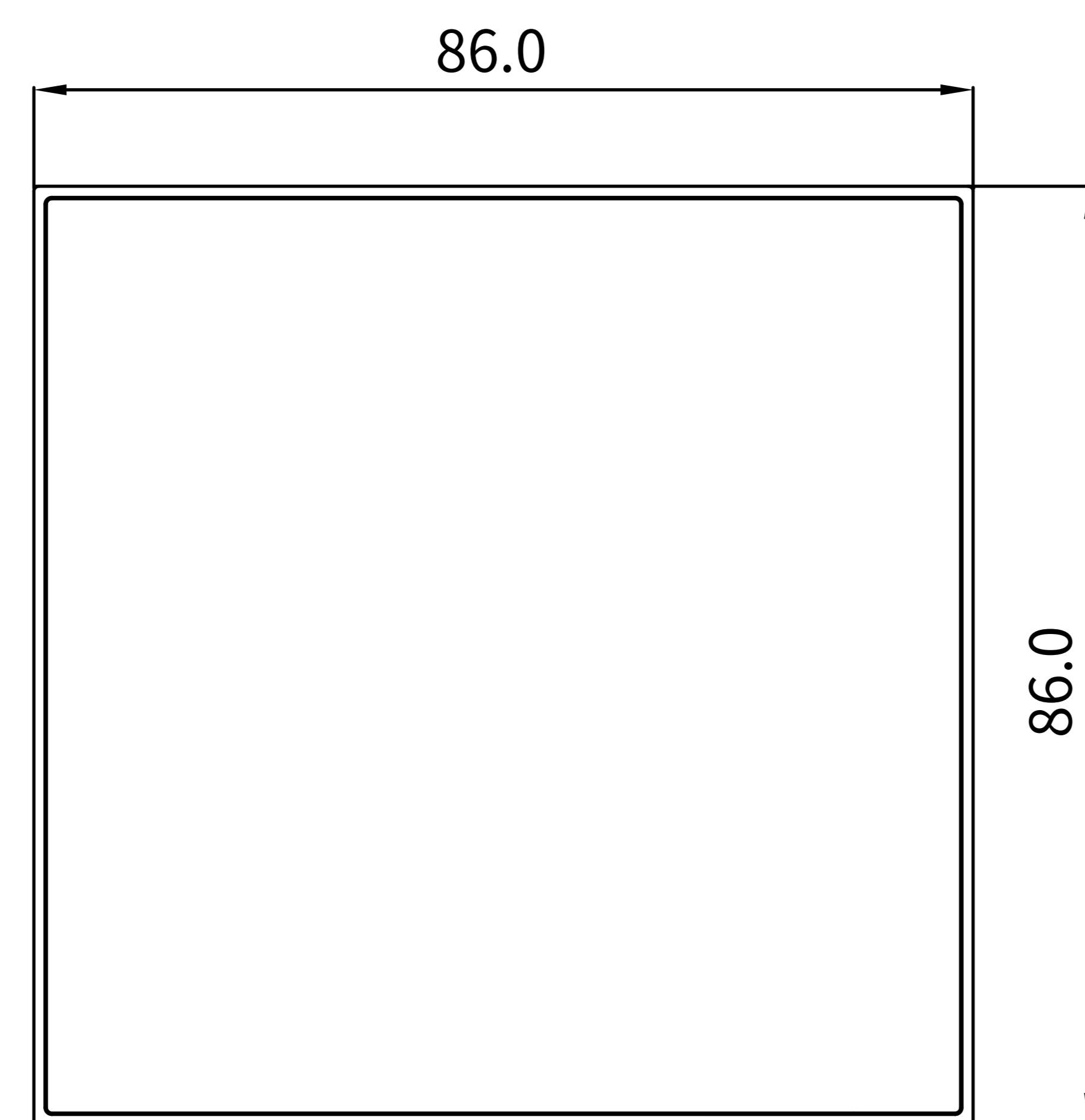

① **FRONT VIEW**

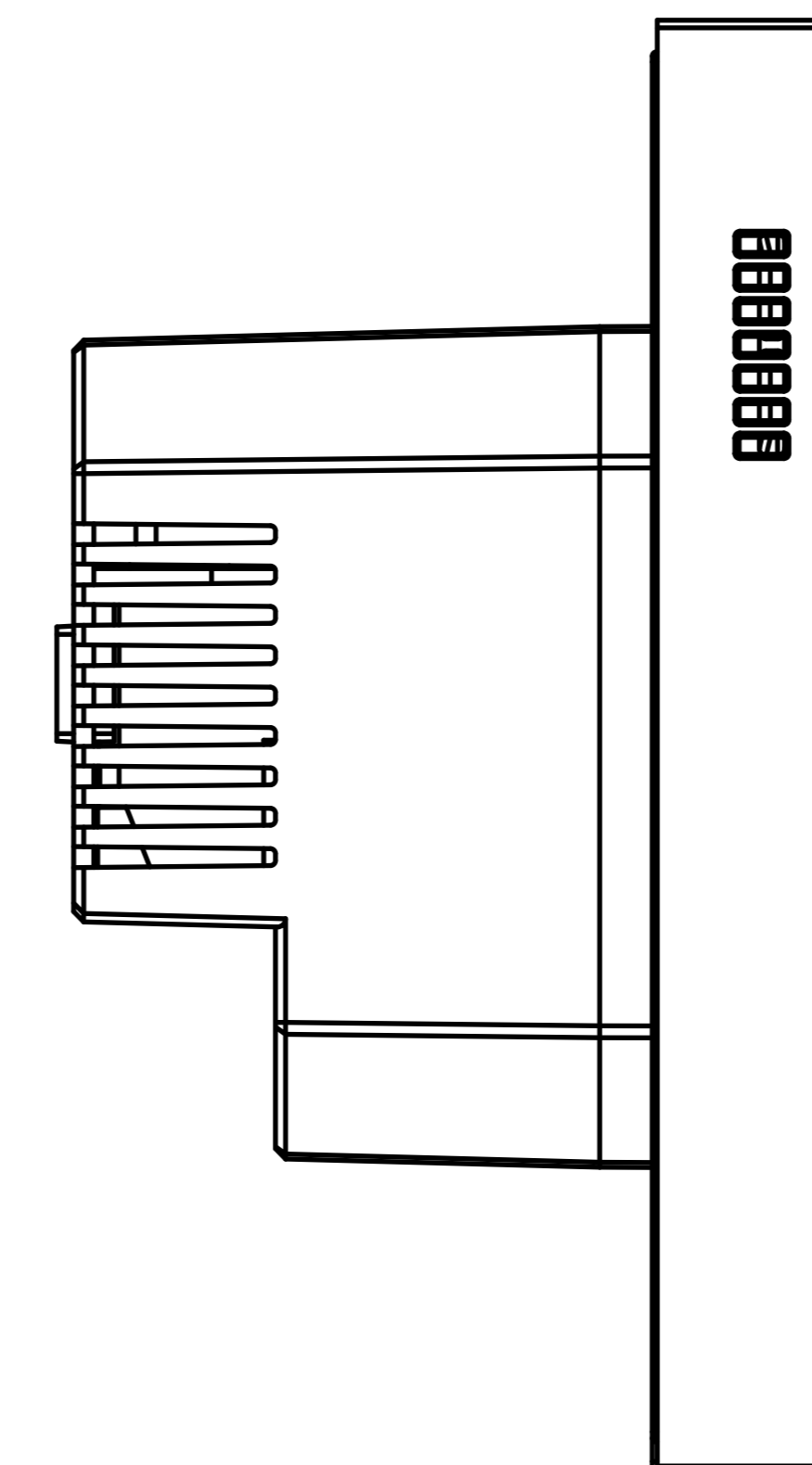

③ **LEFT VIEW**

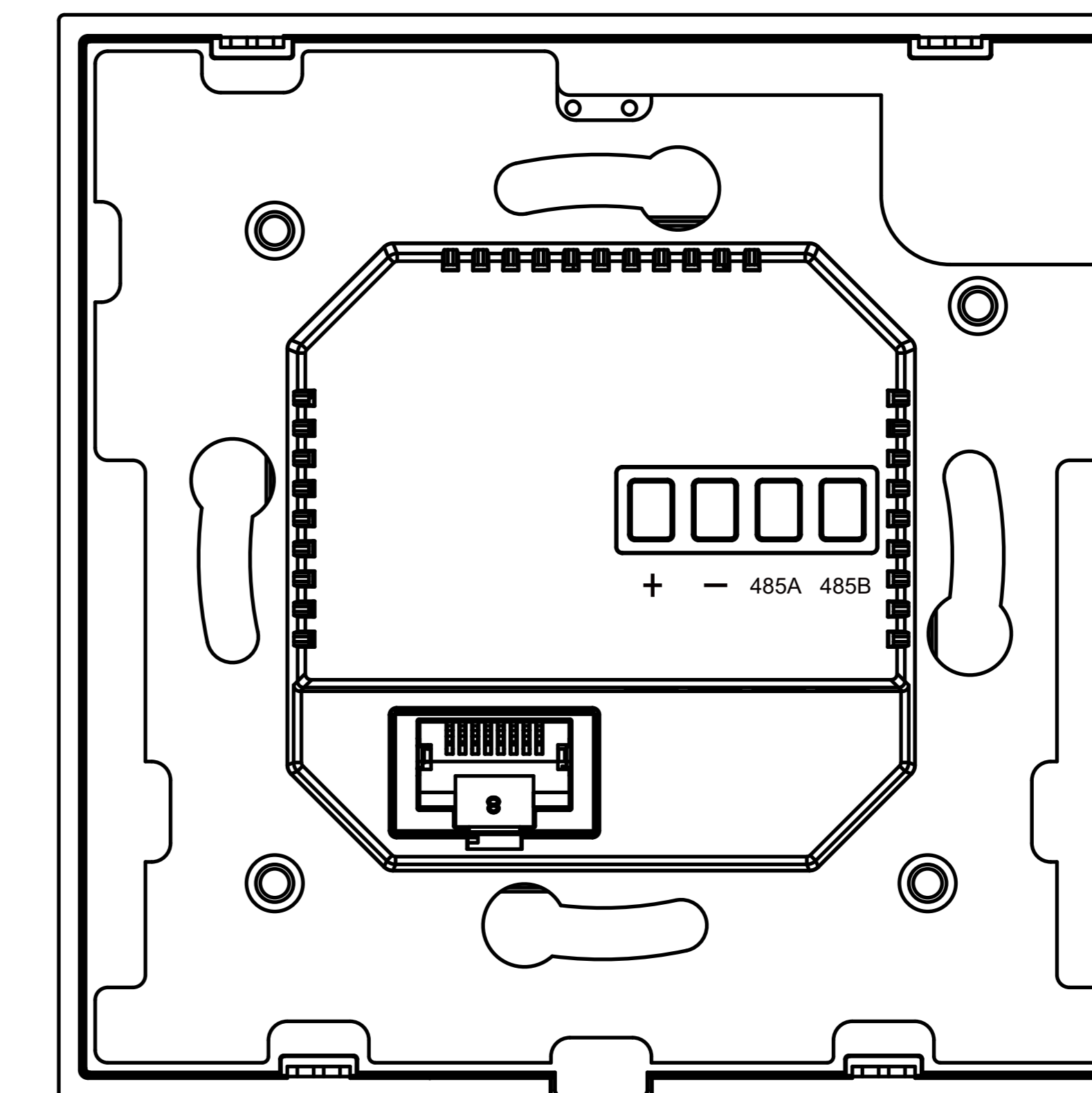

④ **BACK VIEW**

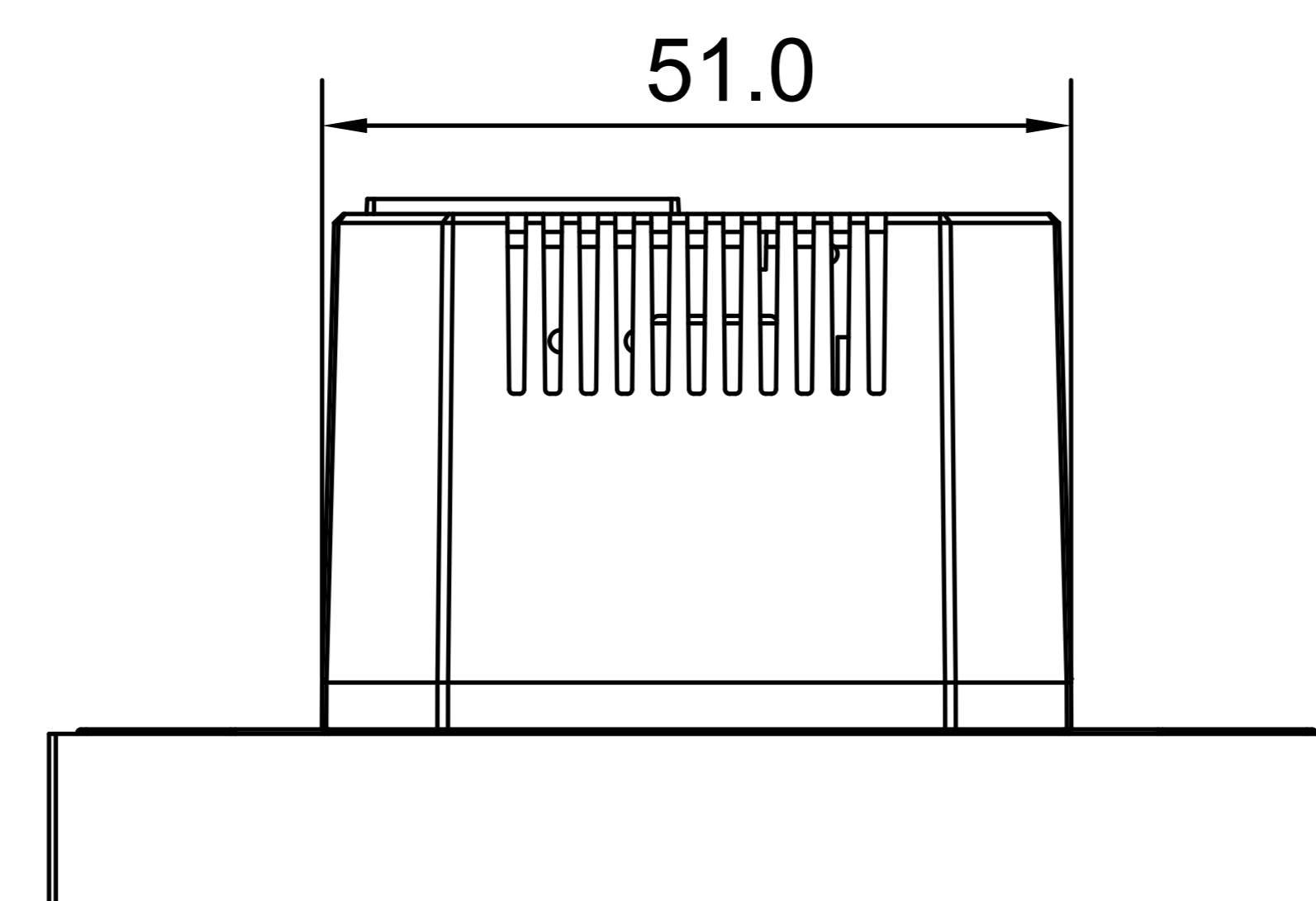

⑥ **TOP VIEW**

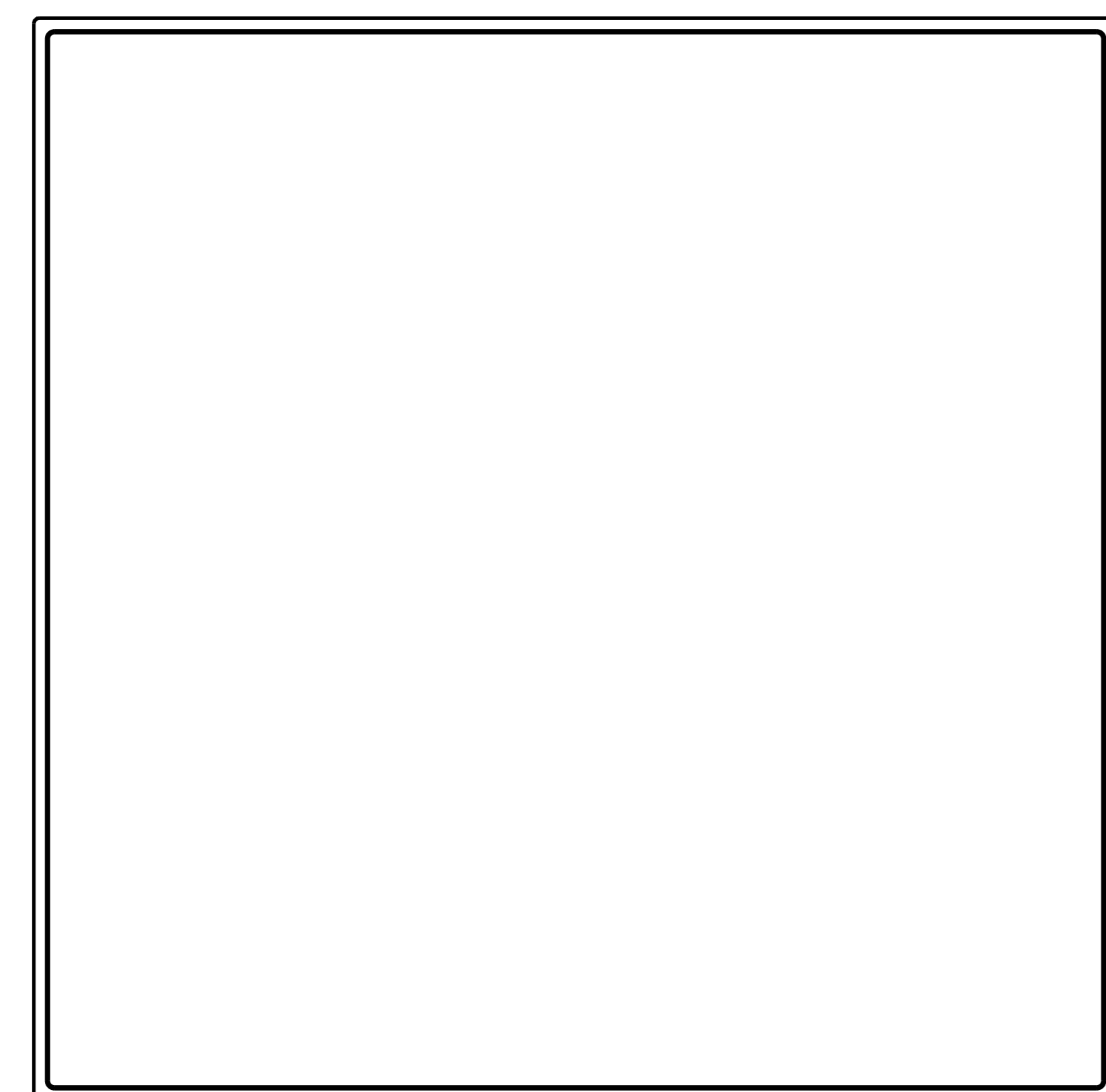

① HYPANEL FRONT VIEW

1100-1600mm TO BOTTOM OF PANEL

ADA Compliance Requirement

GROUND

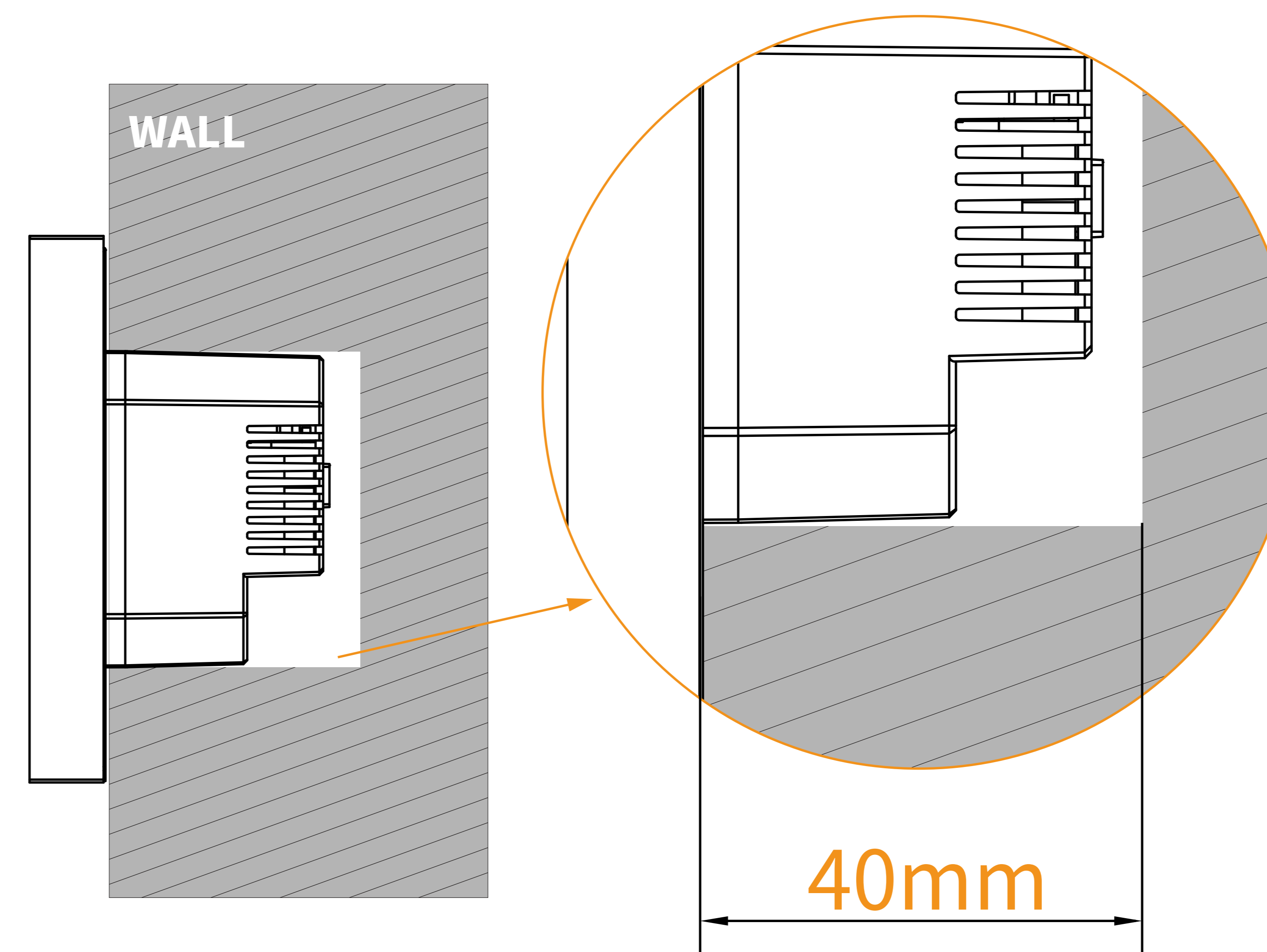
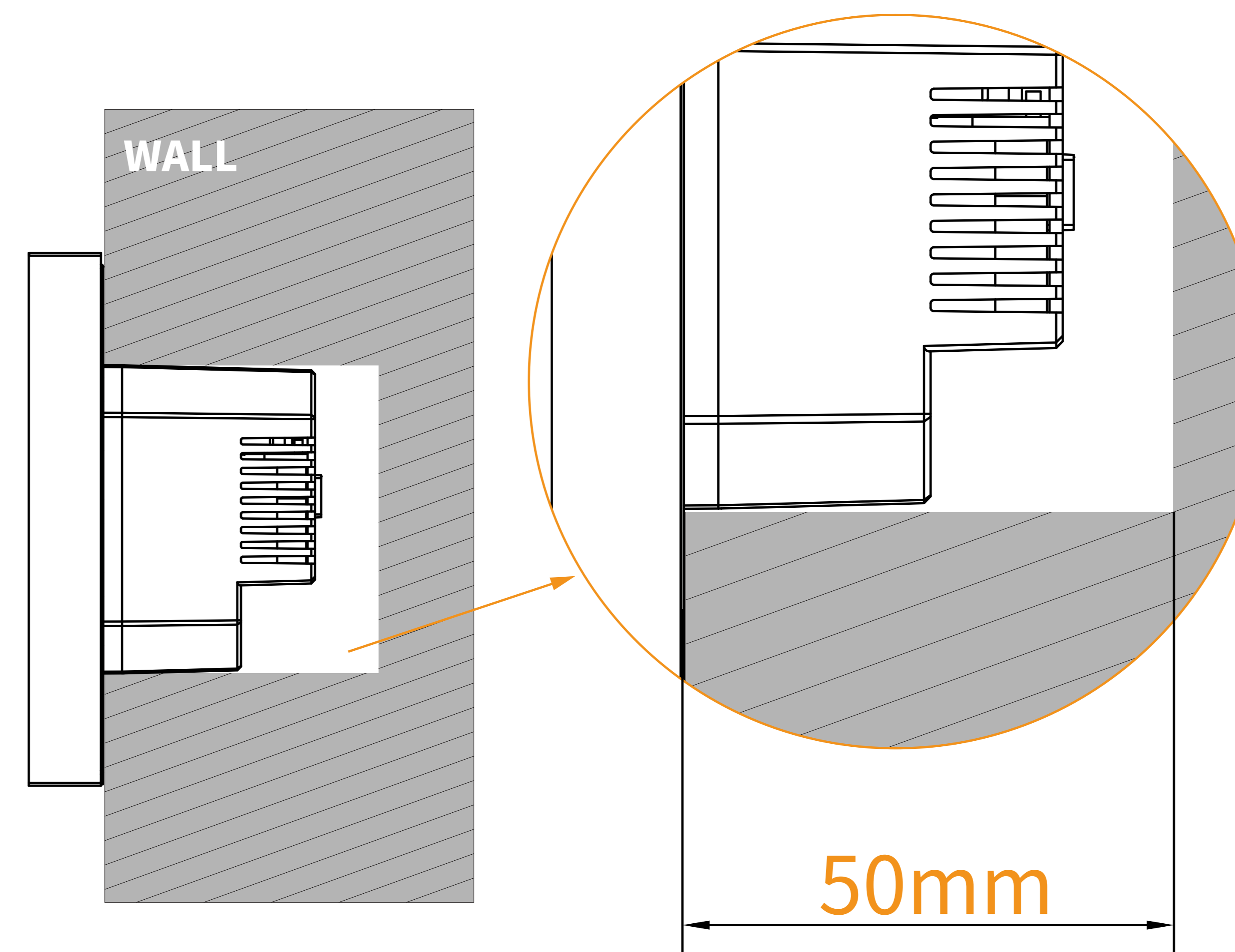

② SIDE VIEW:HYPANEL IN WALL

A 50mm(2 inches) deep electrical box is highly recommended for ease of installation. In some scenarios, especially when the wires can be pushed back into the wall far enough, it may be possible to use a 40mm(1.6 inches) deep box.